







CHAMPAGNE AND SPARKLING WINE  
ШАМПАНСКОЕ И ИГРИСТОЕ ВИНО

		750 мл
N/V	Prosecco «PassaParola» Spumante Brut <i>Veneto, ITALY</i>	3000
N/V	Cava. Cuvee Noire. Reserva Brut. Mont Marcal <i>Penedes, SPAIN</i>	3900
N/V	Cremant d'Alsace «Paul-Edouard» Extra Brut-Bott-Geyl <i>Alsace, FRANCE</i>	5500
2012	Divnomorskoe Blanc de Noir Extra Brut <i>Krasnodar, RUSSIA</i>	5500
N/V	PetNat Chenin Blanc «Somnam Bulles» - Fabien Jouves <i>Sud-Ouest, FRANCE</i>	4500
N/V	Paul Bara Bouzy Grand Cru Brut <i>Champagne, FRANCE</i>	8500
N/V	Sekt Schloss Gobelsburg Blanc de Blancs Brut <i>Kamptal, AUSTRIA</i>	5500
N/V	«R» de Ruinart Brut <i>Champagne, FRANCE</i>	9000
N/V	Delamott Brut <i>Champagne, FRANCE</i>	9500
N/V	Deutz Brut Rose <i>Champagne, FRANCE</i>	10500
N/V	Piper-Heidsieck Brut <i>Champagne, FRANCE</i>	8500
N/V	J. Lassalle Premier Cru Chigny-Les-Roses Brut Preference <i>Champagne, FRANCE</i>	7500
N/V	Lilbert-Fils Cramant Grand Cru Blanc de Blanc Brut <i>Champagne, FRANCE</i>	10500
N/V	Moet & Chandon Brut Imperial <i>Champagne, FRANCE</i>	11000
N/V	Olivier Horiot «Metisse» Extra Brut Noirs & Blancs <i>Champagne, FRANCE</i>	11500
N/V	Ruinart Rose Brut <i>Champagne, FRANCE</i>	13000
N/V	Laurent-Perrier, «Cuvee Rose» Brut <i>Champagne, FRANCE</i>	11500
2008	Veuve Clicquot Vintage rose Brut <i>Champagne, FRANCE</i>	15000
N/V	Moet & Chandon Brut Imperial Rose <i>Champagne, FRANCE</i>	12500
N/V	Ruinart Blancs de Blanc Brut <i>Champagne, FRANCE</i>	8000 (375 мл) 16000
N/V	Agrapart Terroirs Blancs Grand Cru Extra Brut <i>Champagne, FRANCE</i>	18500
2009	Dom Perignon <i>Champagne, FRANCE</i>	29000
2009	«Cristal» - Louis Roederer <i>Champagne, FRANCE</i>	36000
2000	«Dom Perignon» Plenitude 2 <i>Champagne, FRANCE</i>	49000

## SPARKLING AND CHAMPAGNE | ИГРИСТОЕ И ШАМПАНЬ

		125 мл	750 мл
N/V	Prosecco «PassaParola» Spumante Brut <i>Veneto, ITALY</i>	500	3000
N/V	«R» de Ruinart Brut <i>Champagne, FRANCE</i>	1500	9000

## WHITE WINE BY THE GLASS | БЕЛОЕ ВИНО ПО БОКАЛАМ

		150 мл	750 мл
2017	Amatore Bianco (Garganega, Sauvignon Blanc) <i>Veneto, ITALY</i>	500	2500
2016	Chardonnay Semigorye - Villa Victoria <i>Kuban, RUSSIA</i>	600	3000
2017	Sauvignon Blanc «Caroline Bay» Marlborough <i>Marlborough, NEW ZEALAND</i>	800	4000
2017	«Moonlite» (Vermentino/Chardonnay) - Rocca delle Macie <i>Tuscany, ITALY</i>	700	3500
2017	Riesling «Sommerpalais» Reichsgraf von Kesselstatt <i>Mozel, GERMANY</i>	850	4250
 2018	«Pfefferer» Weinberg Dolomiten <i>Alto-Adige, ITALY</i>	900	4500
 2016	Chablis Joseph Drouhin <i>Burgundy, FRANCE</i>	950	4750
 2017	Pinot Grigio - J.Hofstatter <i>Alto-Adige, ITALY</i>	900	4500
 2015	Pinot Blanc - «Manor Divnomorskoe» <i>Krasnodar, RUSSIA</i>	980	4900
 2017	Chardonnay - Luca <i>Mendoza, ARGENTINA</i>	1100	5500
 2015	Chassagne-Montrachet 1-er Cru «Morgeot» - Louis Jadot <i>Burgundy, FRANCE</i>	2400	12000
 2016	Sauternes «Esquisse Moelleux» - Domaine de L'alliance <i>(SWEET) Bordeaux, FRANCE</i>	1200	6000

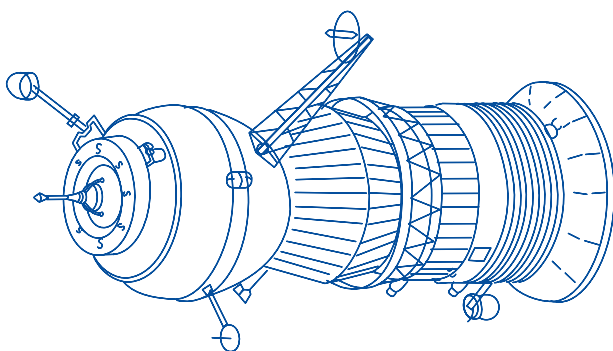

 Инновационная система подачи и хранения вина исключая доступ кислорода.  
Innovative wine service and storage system excluding oxygen access.

Год урожая может варьироваться, пожалуйста, уточняйте у сомелье. Vintage may vary, please check with the sommelier.  
Все цены указаны в рублях, включая НДС. Prices in rubles, VAT included

WHITE WINE BY BOTTLE  
БЕЛОЕ ВИНО ПО БУТЫЛКАМ

FRANCE

	2017	Sauvignon Blanc «Le Blanc de la Mariee» - Domaine de la Garreliere <i>Loire</i>	4900
	2015	Saumur «Les Moulins» - Domaine Guiberteau <i>Loire</i>	6500
	2016	Chablis Joseph Drouhin <i>Burgundy</i>	4750
BIODINAMIC	2016	Sylvaner Pierre Frick <i>Alsace</i>	5600
	2017	Riesling Wolfberger <i>Alsace</i>	5600
	2016	Sauternes «Esquisse Moelleux» - Domaine de L'alliance (SWEET) <i>Bordeaux</i>	6000
	2010	Pouilly-Fume «Baron de L» - De Ladoucette <i>Loire</i>	10500
	2015	Chassagne-Montrachet 1-er Cru «Morgeot» - Louis Jadot <i>Burgundy</i>	12000
	2013	Puligny-Montracet 1-er Cru «Les Pucelles» - Philippe Chavy <i>Burgundy</i>	16000

ITALY

	2017	«Moonlite» (Vermentino/Chardonnay) - Rocca delle Macie <i>Tuscany</i>	3500
	2018	«Pfefferer» Weinberg Dolomiten <i>Alto-Adige</i>	4500
	2017	Bellone Castore Cincinnato <i>Lazio</i>	3500
	2016	Gavi di Gavi - Bersano <i>Piedmont</i>	4700
	2015	Greco-Fiano «Pipoli» - Vigneti del Vulture <i>Basilicata</i>	3150
	2016	Malvasia. Friuli Isonzo - I Feudi di Romans <i>Venezia Giulia</i>	3900
	2017	Pinot Grigio - J.Hofstatter <i>Alto-Adige</i>	4500
	2016	Chardonnay Bissia - La Bioca <i>Piedmont</i>	7500
	2017	Moscato d`Asti «Vigna Senza Nome» - Braida (SWEET LIGHT SPARKLING) <i>Piedmont</i>	4900
	2017	Gavi di Gavi Etichetta Nera - La Scolca <i>Piedmont</i>	8500
	2017	Vermentino Solosole - Poggio al Tesoro <i>Tuscany</i>	5100
	2017	Cometa (Fiano) - Planeta <i>Sicily</i>	6500
	2017	I Frati' Lugana - Ca dei Frati <i>Lombardia</i>	4500
	2016	Frontiere (Tokai Friulano, Pinot Bianco, Chardonnay) Fantinel <i>Friuly</i>	5500
	2016	Arneis «Sant Agostino» - Le Marie <i>Piedmont</i>	4500
	2016	Soave Classico «Monte Grande» - Pra <i>Veneto</i>	5800
	2015	Grechetto. Fiordaliso - Roccafiore <i>Umbria</i>	4500
	2016	Fiano di Avellino "Vino della Stella" Joaquin <i>Campania</i>	7900
	2015	«Cervaro della Sala» - Antinori <i>Umbria</i>	12000

WHITE WINE BY BOTTLE  
БЕЛОЕ ВИНО ПО БУТЫЛКАМ

GERMANY / AUSTRIA

2017	Riesling «Sommerpalais» Reichsgraf von Kesselstatt <i>Mosel, GERMANY</i>	4250
2017	Riesling Dry «Blue slate» - Dr. Loosen <i>Mosel, GERMANY</i>	5200
2015	Riesling Trocken Jacobus - Peter Jakob Kuhn <i>Rheingau, GERMANY</i>	6500
2014	Gruner Veltliner Haidviertel - Weingut Pfaffl <i>Weinviertel, AUSTRIA</i>	4500
2017	Gruner Veltliner Steinfeder - Weingut Jager <i>Wachau, AUSTRIA</i>	4900
2015	Riesling «Terrassen Sonnleiten» - Weingut Pfaffl <i>Niederostreich, AUSTRIA</i>	5900

SPAIN / PORTUGAL

2017	Txakoli Lapazaran <i>Basque country, SPAIN</i>	3500
2014	Formiga de Seda Domini de la Cartoixa <i>Priorat, SPAIN</i>	5250
2017	Alvarinho Soalheiro Granit <i>Vinho Verde, PORTUGAL</i>	4900
2016	Tempranillo Blanco-Marques de la Concordia <i>Rioja, SPAIN</i>	3700

RUSSIA / SERBIA

2016	Chardonnay Semigorye - Villa Victoria <i>Kuban, RUSSIA</i>	3000
2018	Sauvignon Blanc «Orpheline» - Vinarija Kovacevic <i>Fruska Gora, SERBIA</i>	3000
2017	Riesling Abrau-Durso <i>Krasnodar, RUSSIA</i>	4500
2015	Pinot Blanc - «Manor Divnomorskoe» <i>Krasnodar, RUSSIA</i>	4900

NEW ZEALAND / AFRICA

2017	Sauvignon Blanc «Caroline Bay» Marlborough <i>Marlborough, NEW ZEALAND</i>	4000
2015	Chenin Blanc «Baboon`s Swing» - Ayama <i>Paarl, SOUTH AFRICA</i>	3900
2016	Sauvignon Blanc Sur lie «Latitude 41» - Spencer Hill <i>Marlborough, NEW ZEALAND</i>	5500

SOUTHERN AMERICA

2017	Chardonnay «Tradition Reserve» - Chateau Los Boldos <i>Cachapool Valley, CHILE</i>	3000
2016	Albarino Reserva - Garzon <i>Maldonado, URUGUAY</i>	4900
2017	Chardonnay - Luca <i>Mendoza, ARGENTINA</i>	5500

WINE BY BOTTLE  
ВИНО ПО БУТЫЛКАМ

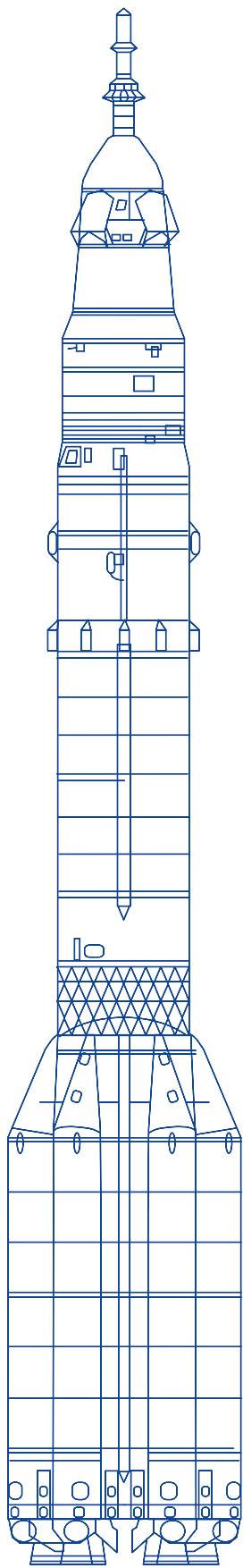

ROSE WINE BY BOTTLE  
РОЗОВОЕ ВИНО ПО БУТЫЛКАМ

2017	«M de Minuty» Rose <i>Provence, FRANCE</i>	3500
2016	Pinot Gris - Villa Victoria <i>Kuban, RUSSIA</i>	2500
2017	«L» de Ayles» Vino de Pago <i>Aragon, SPAIN</i>	4500
2015	«Scalabrone» - Tenuta Guado Al Tasso (Antinori) <i>Toscana, ITALY</i>	4800

RED WINE BY BOTTLE  
КРАСНОЕ ВИНО ПО БУТЫЛКАМ

FRANCE

	2017	Gamay «Raisins Gaulois» - Marcel Lapierre <i>Beaujolais</i>	4500
	2016	Le Vin Est Une Fete - Domaine Elian Da Ros Cotes Du Marnandais <i>Sud-Ouest</i>	4500
	2014	L'Equilibre - Villa Prissette <i>Languedoc</i>	4600
BIODINAMIC	2017	Reviens Gamay! Sylvain Bock <i>Ardeche</i>	4600
	2015	Crozes-Hermitage «La Matiniere» - Ferratton Pere & Fils <i>Rhone</i>	5500
BIODINAMIC	2015	Domaine Patrick Baudouin, «Les Coteaux d'Ardenay» <i>Anjou</i>	5500
	2014	Beaujolais Brouilly Vieilles Vignes - Georges Descombes <i>Beaujolais</i>	6900
	2014	Chateau Le Crock Saint - Estephe <i>Bordeaux</i>	7500
	2006	Chateau Clarke Baron Edmond de Rothschild <i>Bordeaux</i>	9350
	2008	Chateau Haut Milon Pauillac <i>Bordeaux</i>	10350
	2015	Chambolle-Musigny Francois Feuillet <i>Burgundy</i>	12500
	2008	Nuit-Saint-Georges 1-er Cru «Les Boudots» - Louis Jadot <i>Burgundy</i>	16500
	2011	Vosne-Romanee 1-er Cru «Les Chaumes» - Louis Jadot <i>Burgundy</i>	25000

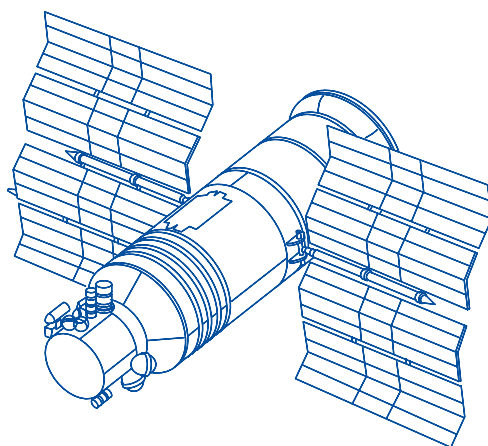

RED WINE BY BOTTLE  
КРАСНОЕ ВИНО ПО БУТЫЛКАМ

ITALY

	2015	Nero d'Avola «Nerd» - Ferro13 <i>Sicily</i>	3500
	2017	Nero Buono Polluce Cicinnato <i>Lazio</i>	3500
	2016	Primitivo - «Luccarelli» <i>Puglia</i>	3750
	2016	Chianti Classico-Rocca delle Macie <i>Toscana</i>	4500
	2016	IL Sangiovese - Noelia Ricci <i>Emilia-Romagna</i>	4500
	2016	Rosso Di Montalcino-Terre Nere <i>Toscana</i>	4600
	2017	Etna Rosso (Nerello Mascalese) - Planeta <i>Sicily</i>	4900
	2016	Yantra (Cabernet-Merlot) - Tenuta Sette Cieli <i>Toscana</i>	5500
BIODINAMIC	2014	Casa Wallace Il Rosso Monferrato <i>Piedmont</i>	5500
	2011	Tenuta Sant'Helena «Venko» -Fantinel <i>Friuly</i>	6000
	2016	Valpolicella DOC Borgomarcellise - Marion <i>Veneto</i>	6000
	2010	Chianti Classico Riserva «Le Fioraie» - Piemaggio <i>Toscana</i>	6200
	2010	Chianti Classico Reserva IL Campitello-Monteraponi <i>Toscana</i>	7200
	2016	Le Volte Dell` Ornellaia <i>Toscana</i>	7500
	2012	«Palazzo Della Torre» - Allegrini <i>Veneto</i>	7500
	2012	Gattinara - Travaglini <i>Piedmont</i>	7500
	2011	Croatina «Pertichetta» - Vigneti Massa <i>Piedmont</i>	7900
	2014	Barolo Gallinotto - Mauro Molino <i>Piedmont</i>	9900
	2012	Amarone della Valpolicella - Rubinelli Vajol <i>Veneto</i>	10500
	2012	Barone di Serramarrocco (Pignatello) <i>Sicily</i>	10500
	2014	Kurn i-Oasi degli Angeli (Demy Sweet) <i>Marke</i>	12000
	2014	Barolo-Pio Cesare <i>Piedmont</i>	13500
	2013	Barbaresco Montestefano - Rivella Serafino di Rivella Teobaldo <i>Piedmont</i>	18500
	2015	«Tignanello» - Antinori <i>Toscana</i>	18500
	2011	"50 & 50" - Avignonesi - Capannelle <i>Tuscany</i>	26000
	2015	Sassicaia Bolgheri - Tenuta San Guido <i>Toscana</i>	39000
	2012	Ornellaia - Tenuta della Ornellaia <i>Toscana</i>	60000

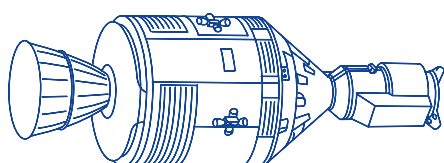

RED WINE BY BOTTLE  
КРАСНОЕ ВИНО ПО БУТЫЛКАМ

GERMANY / AUSTRIA

2016	Zweigelt - Domaene Gobelsburg <i>Niederostreich, AUSTRIA</i>	3400
2016	Blaufrankisch - Weingut Ernst Triebaumer <i>Burgenland, AUSTRIA</i>	3500
2016	Spatburgunder - Meyer-Nakel <i>Aar, GERMANY</i>	5500
BIODINAMIC 2015	«Atanasius» (Zweigelt - Blaufrankisch) Gut Oggau <i>Burgenland, AUSTRIA</i>	8900

SPAIN / PORTUGAL

2014	Rioja Crianza - Finca Besaya <i>Rioja, SPAIN</i>	3750
2017	Tempranillo «El Ilusionista» Joven-Adegas Tollodouro <i>Ribera del Duero, SPAIN</i>	3900
2015	Syrah Natural Reserve-Marques d la Concordia <i>Castilla y Leon, SPAIN</i>	6500
2016	Crossos. Priorat. Domini de la Cartoixa. DOQ <i>Priorat, SPAIN</i>	5500
2015	Garnacha. Navarra. La Tormenta.Vivantis. DO <i>Navarra, SPAIN</i>	4500
2012	Lecco Reserva-Bodegas Resalte de Pecafiel <i>Ribera del Duero, SPAIN</i>	5500
2013	Fio de Terra Tinto-Slava Ismailovs and Luis Lourenco <i>Dao, PORTUGAL</i>	5900

USA / SOUTHERN AMERICA

2017	Syrah «Tradition Reserve» - Chateau Los Boldos <i>Cachapoal Valley, CHILE</i>	3000
2015	Cabernet Sauvignon - Murphy Goode <i>California, USA</i>	5500
2013	Cabernet Sauvignon Gran Reserva - Santa Rita <i>Maipo, CHILE</i>	4500
2015	Zinfandel Gnarly Head Old Vine <i>Louday, California, USA</i>	5500
2014	Malbec-Rutini <i>Mendoza, ARGENTINA</i>	7500
2016	Geyserville Alexander Valley - Ridge <i>California, USA</i>	11500

RUSSIA / SERBIA

2011	Cabernet Sauvignon - Burnier <i>Kuban, RUSSIA</i>	4250
2014	Marselan - WINERY «Manor Divnomorskoe» <i>Krasnodar, RUSSIA</i>	4900
2012	Pinot Noir «Trijumf» Aleksandrovic <i>Vinča, SERBIA</i>	6900

AFRICA / OCEANIA









2017	Shiraz «Tenacity» Old Vine - Two Hands <i>McLaren Valley, AUSTRALIA</i>	4300
2016	Pinotage Fairview <i>Paarl, SOUTH AFRICA</i>	4800
2017	Pinot Noir «Petit Clos» - Clos Henri <i>Marlborough, NEW ZEALAND</i>	5500
2007	Shiraz «Eileen Hardy» - Hardys <i>McLaren Valley, AUSTRALIA</i>	24500



## ROSE BY THE GLASS | РОЗОВОЕ ВИНО ПО БОКАЛАМ

		150 мл	750 мл
	2016 Pinot Gris - Villa Victoria <i>Kuban, RUSSIA</i>	500	2500
	2017 «L» de Ayles» Vino de Pago <i>Aragon, SPAIN</i>	900	4500

## RED WINE BY THE GLASS | КРАСНОЕ ВИНО ПО БОКАЛАМ

		150 мл	750 мл
	2017 «Caliza» (Merlot, Syrah, Tempranillo) <i>La Mancha, SPAIN</i>	500	2500
	2017 Syrah «Tradition Reserve» - Chateau Los Boldos <i>Cachapoal Valley, CHILE</i>	600	3000
	2015 Nero d'Avola «Nerd» - Ferro13 <i>Sicily, ITALY</i>	700	3500
	2016 Primitivo - «Luccarelli» <i>Puglia, ITALY</i>	750	3750
	2011 Cabernet Sauvignon - Burnier <i>Kuban, RUSSIA</i>	850	4250
	2016 Chianti Classico - Rocca delle Macie <i>Tuscany, ITALY</i>	900	4500
	2016 Le vin Est Une Fete - Domaine Elian Da Ros <i>Sud-Ouest, FRANCE</i>	900	4500
	2016 IL Sangiovese - NOELIA RICCI <i>Emilia-Romagna, ITALY</i>	900	4500
	2015 Pinot Noir Cuvee Edme «Signature» - Maison Champy <i>Burgundy, FRANCE</i>	1100	5500
	2012 Lecco Reserva-Bodegas Resalte de Pecafiel <i>Ribera del Duero, SPAIN</i>	1100	5500
	2012 Gattinara - Travaglini <i>Piedmont, ITALY</i>	1500	7500
	2012 Amarone della Valpolicella - Rubinelli Vajol <i>Veneto, ITALY</i>	2100	10500
	2014 Chateau Le Crock Saint - Estephe <i>Bordeaux, FRANCE</i>	1500	7500
	2018 «Tignanello» - Antinori <i>Toscana, ITALY</i>	3700	18500

